

抗硫车用宽电极厚膜贴片电阻承认书-AW 系列

Approval Specification for Anti-Sulfuration Wide Terminal Thick Film Chip Resistors-Type AW

1. 范围 (scope) :

1.1 适用于本公司所生产的无铅、抗硫车用宽电极厚膜贴片电阻 AW 系列

This specification applies to Anti-Sulfuration wide Terminal thick film chip resistors which meet requirements of Pb free.

1.2 本公司的无铅产品指的贴片电阻端电极无铅，而存在于电阻层的玻璃中的符合 RoHS 豁免条款。

There no lead exists in terminal of resistor, and lead which exist in glass of resistor layer meets RoHS exemption.

1.3 符合 AEC-Q200 标准。

Comply with AEC-Q200 standard.

1.4 车用

Automotive



2. 产品料号 (part number) :

1225 2W 1% 20Ω

AW1225FB20R0G

顺海科技
0755-28100016





<u>AW</u>	<u>1225</u>	<u>F</u>	<u>B</u>	<u>20R0</u>	<u>G</u>
类型(Type) AW: 抗硫车用宽 电极厚膜贴片电 阻 (Anti-Sulfuration wide Terminal thick film chip resistors)	尺寸(Size) 0612 1020 1225	公差 Tolerance F=±1% J=±5%	额定功率 Rated Power 1= 1W 2=3/4W B= 2W	阻值 Resistance value ±1% : 20R0=20Ω 49R9=49.9Ω 1002=10KΩ ±5% : 06R8=6.8Ω 0200=20Ω 0564=560KΩ	包装代码 Packing Code G= reel (卷装) V= bulk (散料) S= Double Standard Quantity (两倍卷 盘标准包装量)

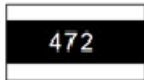

抗硫车用宽电极厚膜贴片电阻承认书-AW 系列

Approval Specification for Anti-Sulfuration Wide Terminal Thick Film Chip Resistors-Type AW

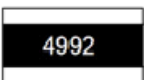
3. 电阻本体字码标示 (Marking on the Resistor's Body) :

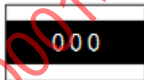
※ 公差±5%的产品，以三字码标示，前两位表示阻值的有效数字，最后一位表示 10 的乘幂 ±5% tolerance product: the marking is 3 digits, the first 2 digits are significant figures of resistance value and the 3rd one denotes the power number of 10, (10 ^x)		472=47×10 ² =4.7K Ω
		10Ω 以下标示：5R6=5.6Ω Below 10Ω: 5R6=5.6Ω
※ ±1%的产品，以四字码标示，前三位表示阻值的有效数字，最后一位表示 10 的乘幂 ±1% tolerance product: the marking is 4 digits, the first 3 digits are significant figures of resistance value and the 4th one denotes the power number of 10, (10 ^x)		4992=499×10 ² =49.9K Ω
		100Ω 以下标示：20R0=20Ω Below 100Ω: 20R0=20Ω
※ 0 欧姆产品，采用 000 三位代码标示。 0 Ω Products, use 000 3digits code to indicate the resistance value.		000=0Ω

4. 尺寸 (dimension) :

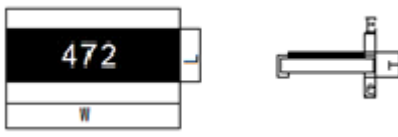
尺寸 dimension					
	单位 (unit) : mm				
型别 (Type)	L	W	T	E	e
AW0612	1.60±0.15	3.20±0.20	0.60±0.10	0.30±0.20	0.45±0.15
AW1020	2.50±0.15	5.00±0.15	0.60±0.10	0.40±0.20	0.75±0.15
AW1225	3.10±0.15	6.30±0.15	0.60±0.10	0.45±0.20	0.75±0.15



5. 功率衰减曲线 (Derating Curve) :

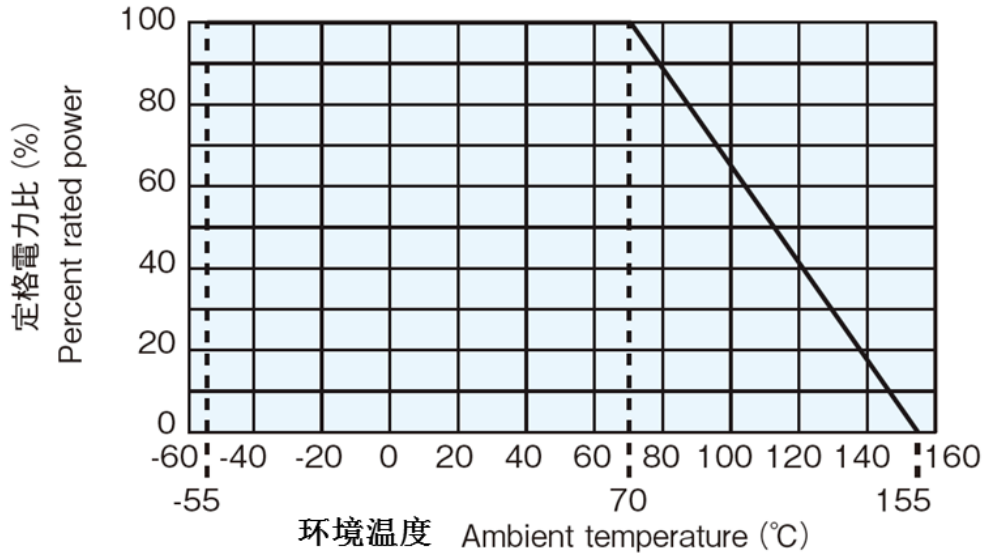

工作温度范围 (Operating Temperature Range) : -55°C ~ +155°C ;

储存条件 (storage condition) : 5~30°C, 30~75%RH.

6.电阻结构 (Construction) :

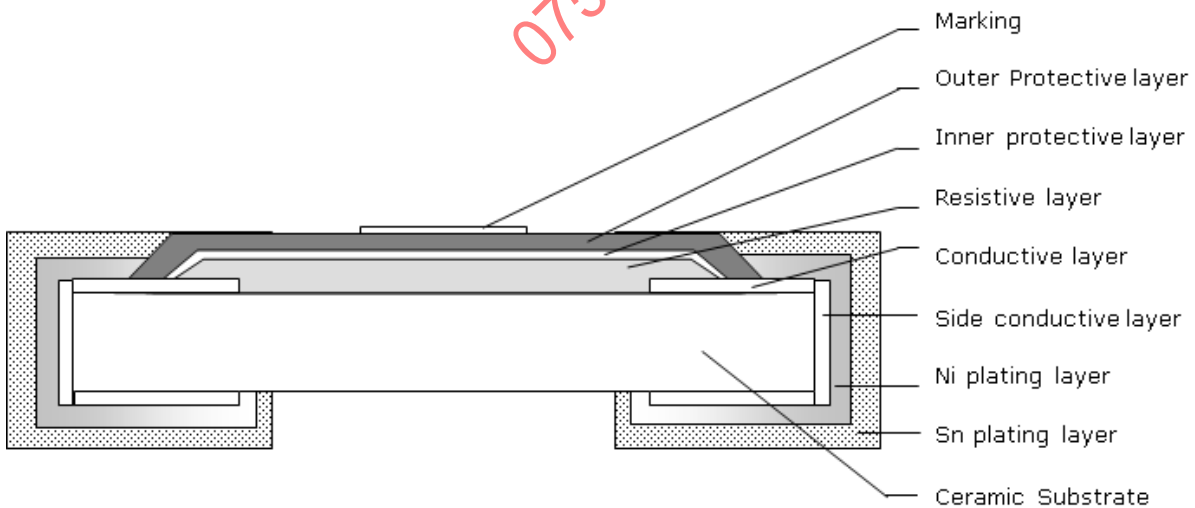



抗硫车用宽电极厚膜贴片电阻承认书-AW 系列

Approval Specification for Anti-Sulfuration Wide Terminal Thick Film Chip Resistors-Type AW

No.	结构 construction	主要材料 Major material
1	陶瓷基板 Ceramic substrate	三氧化二铝 Al ₂ O ₃
2	银电极 Conductive layer	银钯 AgPd
3	侧电极 Side conductive layer	镍铬合金 NiCr
4	阻体层 Resistive layer	氧化钌+玻璃 RuO ₂ + glass
5	内保护层 Inner protective layer	玻璃 Glass
6	外保护层 Outer Protective layer	环氧树脂 Epoxy
7	文字 Marking	环氧树脂 Epoxy
8	镍电极 Ni plating layer	镍 Ni
9	锡电极 Sn plating layer	雾锡 Matte Tin

7. 阻值范围 (resistance range) :

型别 Type	阻值范围 Resistance Range	
	1%	5%
AW0612	1Ω~1MΩ, Jumper	1Ω~1MΩ, Jumper
AW1020	1Ω~1MΩ, Jumper	1Ω~1MΩ, Jumper
AW1225	1Ω~1MΩ, Jumper	1Ω~1MΩ, Jumper



抗硫车用宽电极厚膜贴片电阻承认书-AW 系列

Approval Specification for Anti-Sulfuration Wide Terminal Thick Film Chip Resistors-Type AW

8. 电气特性 (electrical characteristics) :

型别 Type	AW0612	AW1020	AW1225
额定功率 Rated power	3/4W	1W	2W
最大工作电压 Max Working Voltage	200V	200V	200V
最大过负荷电压 Max Overload Voltage	400V	400V	400V
绝缘耐压 Dielectric Withstanding Voltage	570V	710V	710V
零欧姆阻值 Resistance Value of Jumper	<50mΩ	<50mΩ	<50mΩ
零欧姆额定电流 Rated Current of Jumper	2.0A	2.0A	2.0A
零欧姆电阻最大电流 Max Current of Jumper	10.0A	10.0A	10.0A

备注 (remark) :

※ 额定电压计算公式 (The rated voltage is calculated by the following formula) :

$$E = \sqrt{RP}$$

E : 额定电压 (Rated Voltage) (V)

P : 额定功率 (Rated Power) (W)

R : 电阻阻值 (Resistance) (ohm)

※ 如果计算出的电压超过此型别的最大工作电压, 则此型别的最大工作电压为此电阻的额定电压。
 In case the value calculated by the formula exceed the maximum working voltage as above table 9, the maximum working voltage shall be regarded as rated voltage.



抗硫车用宽电极厚膜贴片电阻承认书-AW 系列

Approval Specification for Anti-Sulfuration Wide Terminal Thick Film Chip Resistors-Type AW

9. 性能信赖性测试 (Performance Reliability Test Methods)

内容 Item	测试方法 Test Methods	测试条件 Test Conditions	规格 Specification
温度系数 Temperature Coefficient	JIS C 5201 4.8	$TCR = (R - R_0) / (t - t_0) R_0 \times 10^6$ (ppm) R_0 电阻在室温下的阻值(resistance at room temperature) R 电阻在 125°C 或 -55°C 下的阻值(resistance at 125°C or -55°C) t_0 室温(room temperature) t 测试温度 (test temperature 125°C or -55°C)	$1\Omega \leq R \leq 10\Omega$: ± 200 PPM/°C $10\Omega < R \leq 1M\Omega$: ± 100 PPM/°C
焊锡性 Solderability	J-STD-002	用于引脚型和表面贴装型元件，不需要电气测试。放大倍数 50 倍。 测试条件: 表面贴装型: a)方法 B, 干热@155°C,4 小时,@235°C,3±0.5 秒 b)方法 B, 蒸煮 8 小时, @235°C,3±0.5 秒 For pin and surface-mount components, no electrical testing required. Magnification 50 times. Test conditions: Surface mount type: A) Method B, dry heat @155°C, 4 hours, @235°C, 3±0.5 seconds B) Method B: cook for 8 hours at @235°C, 3±0.5 seconds	最少 95% 面积上锡 (Min 95% coverage)
绝缘电阻 Insulation resistance	JIS C 5201 4.6	电阻本体上加载绝缘耐压 60±5 秒后，测量绝缘阻抗。 Applied the dielectric withstanding voltage on the center of body for 60±5seconds. Then measure insulation resistance.	>10GΩ
绝缘耐压 Dielectric withstanding voltage	JIS C 5201 4.7	电阻本体上加载绝缘耐压 60±5 秒。 Applied the dielectric withstanding voltage on the center of body for 60±5seconds.	无击穿、飞弧及可见机械性损伤 No evidence of flashover, mechanical damage arcing or insulation breakdown



抗硫车用宽电极厚膜贴片电阻承认书-AW 系列

Approval Specification for Anti-Sulfuration Wide Terminal Thick Film Chip Resistors-Type AW

内容 Item	测试方法 Test Methods	测试条件 Test Conditions	规格 Specification
短时间过负荷 Short-time overload	JIS C 5201 4.13	加载 2.5 倍的额定电压，时间 5 秒后测量试验前后的阻值变化率。 Applied 2.5 times of rated voltage for 5 second. Measure the variation of resistance. $\Delta R\% = \frac{R_2 - R_1}{R_1} * 100 \text{-----} (\%)$ R1 = 试验前阻值(resistance before test) R2 = 试验后阻值(resistance after test)	±(1.00%+0.05 Ω) Max
抗焊锡热 Resistance to soldering heat	MIL-STD-202 METHOD 210	锡炉温度 260±5℃,时间 10±0.5 秒，样品不进行预热。注意:单一波峰焊-表面贴装元件按程序，浸入器件本体的 1.5mm 的深度. Soldering bath at 260±5℃ for 10±0.5sec. No pre-heat of samples. Note: Single Wave Solder-Procedure 2 for SMD and Procedure 1 for Leaded with solder within 1.5mm of device body. $\Delta R\% = \frac{R_2 - R_1}{R_1} * 100 \text{-----} (\%)$ R1 = 试验前阻值(resistance before test) R2 = 试验后阻值(resistance after test)	±(1.00%+0.05 Ω) Max
端子弯曲 Board Flex	AEC-Q200-005	焊接在 PCB 板上，0204~0612 弯板深度 5mm，1012 以上弯板深度 2mm；保持 60±1s Reflow solder the samples on PCB，0204~0612 bending plate depth 5mm, 1012 above bending plate depth 2mm;Keep 60±1 s $\Delta R\% = \frac{R_2 - R_1}{R_1} * 100 \text{-----} (\%)$ R1 = 试验前阻值(resistance before test) R2 = 试验后阻值(resistance after test)	±(1.00%+0.05 Ω) Max



抗硫车用宽电极厚膜贴片电阻承认书-AW 系列

Approval Specification for Anti-Sulfuration Wide Terminal Thick Film Chip Resistors-Type AW

内容 Item	测试方法 Test Methods	测试条件 Test Conditions	规格 Specification
负荷寿命 Operational life	MIL-STD-202 METHOD 108	恒定温度 125 °C 加载 额定功率，ON TIME:1.5H，OFF TIME:0.5H，额定电压 1000 ⁺²⁴ / ₋₀ 小时 Load rated power, ON TIME:1.5H, OFF TIME:0.5H, rated voltage 1000 +24/-0 hours $\Delta R\% = \frac{R_2 - R_1}{R_1} * 100 \text{-----} (\%)$ R1 = 试验前阻值(resistance before test) R2 = 试验后阻值(resistance after test)	±(2.00%+0.05 Ω) Max
耐湿特性 Biased Humidity	MIL-STD-202 METHOD 103	加载 10%额定功率，85°C/85%RH, 持续通电 1000H,试验结束 24±4 小时后进行测 试 1000 hours 85°C/85%RH. Note: Specified conditions: 10% of operating power. Measurement at 24±4 hours after test conclusion. $\Delta R\% = \frac{R_2 - R_1}{R_1} * 100 \text{-----} (\%)$ R1 = 试验前阻值(resistance before test) R2 = 试验后阻值(resistance after test)	±(2.00%+0.05 Ω) Max
温度循环 Temperature cycling	JESD22 METHOD JA -104	-55°C ~+ 155°C，循环 1000 次，在每一个极限 温度持续时间不超过 30 分钟，且温度转换时 间不超过 1 分钟，试验结束 24±4 小时后进行 测试。 1000 Cycles (-55°C to +155°C) Measurement at 24±4 hours after test conclusion. 30min maximum dwell time at each temperature extreme. 1min. maximum transition time. $\Delta R\% = \frac{R_2 - R_1}{R_1} * 100 \text{-----} (\%)$ R1 = 试验前阻值(resistance before test) R2 = 试验后阻值(resistance after test)	±(2.0%+0.05 Ω) Max



抗硫车用宽电极厚膜贴片电阻承认书-AW 系列

Approval Specification for Anti-Sulfuration Wide Terminal Thick Film Chip Resistors-Type AW

内容 Item	测试方法 Test Methods	测试条件 Test Conditions	规格 Specification
温湿循环 Moisture resistance	MIL-STD-202 METHOD 106	25 ° C~65 ° C,90~100%RH, 2.5 小时 ; 65 ° C 90~100%RH, 3小时; 65°C~25°C,80~100%RH,2.5小时,10个循环,试验 结束24±4小时后进行测试. 25 ° C~65 ° C,90~100%RH, 2.5H; 65 ° C 90~100%RH, 3H; 65°C~25°C 80~100%RH, 2.5H, 10 cycles, Measurement at 24±4 hours after test conclusion. $\Delta R\% = \frac{R_2 - R_1}{R_1} * 100 \text{-----} (\%)$ R1 = 试验前阻值(resistance before test) R2 = 试验后阻值(resistance after test)	±(2.00%+0.05 Ω) Max
高温储存 High Temperature Exposure(Storage)	MIL-STD-202 METHOD 108	155°C 下放置 1000h,不加载功率, 试验结束 24±4 小时后进行测试. 1000 hrs. @ T=155°C. Unpowered. Measurement at 24±4 hours after test conclusion $\Delta R\% = \frac{R_2 - R_1}{R_1} * 100 \text{-----} (\%)$ R1 = 试验前阻值(resistance before test) R2 = 试验后阻值(resistance after test)	±(1.00%+0.05 Ω) Max
ESD 试验 ESD test	AEC-Q200-002	加载规定静电电压2次/间隔1秒, 0402规 格:0.5KV, 0603规格:1KV, 其它规格2KV. 0402: 0.5KV, 0603: 1.0KV, Other:2KV, 2times/1s $\Delta R\% = \frac{R_2 - R_1}{R_1} * 100 \text{-----} (\%)$ R1 = 试验前阻值(resistance before test) R2 = 试验后阻值(resistance after test)	±(3.0%+0.05 Ω) Max



抗硫车用宽电极厚膜贴片电阻承认书-AW 系列

Approval Specification for Anti-Sulfuration Wide Terminal Thick Film Chip Resistors-Type AW

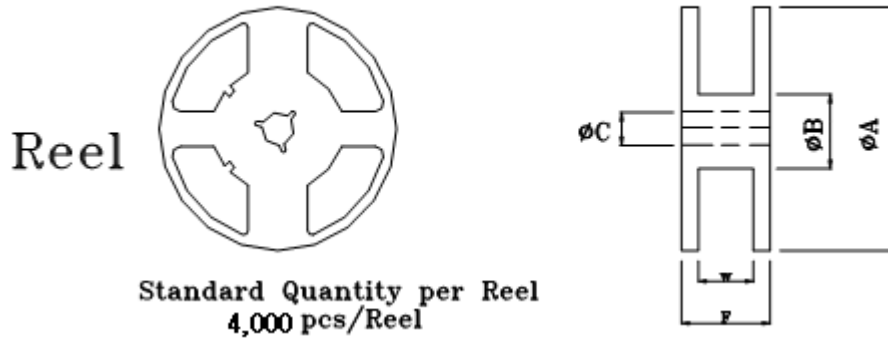

10.2 包装尺寸 (packing dimension)

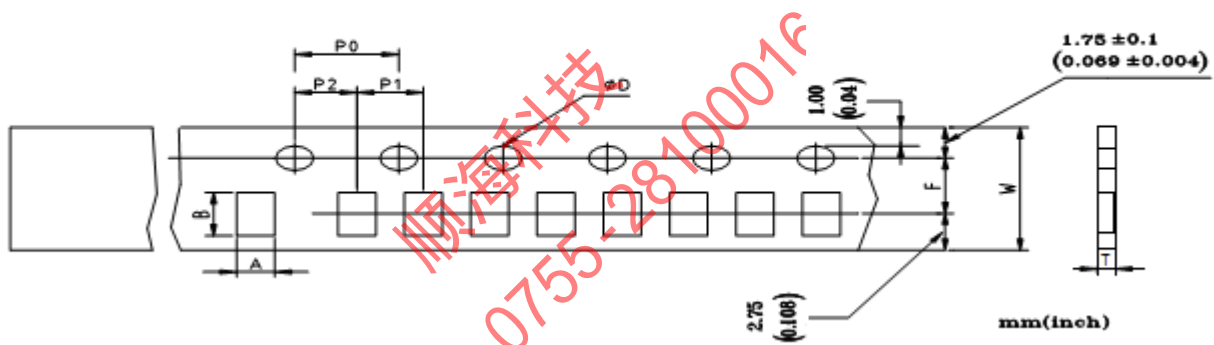

Unit: mm

尺寸 Dimensions	A	B	D	F	P0	P1	P2	W	T
AW0612	2.00±0.20	3.60±0.20	1.50± ^{0.1} / _{0.0}	3.50±0.05	4.00±0.10	4.00±0.10	2.00±0.05	8.00±0.20	0.75±0.07
AW1020	3.30±0.20	4.60±0.20	1.50± ^{0.1} / _{0.0}	5.50±0.05	4.00±0.10	4.00±0.10	2.00±0.05	12.0±0.10	1.0±0.07
AW1225	3.40±0.10	6.60±0.10	1.50± ^{0.1} / _{0.0}	5.50±0.05	4.00±0.10	4.00±0.10	2.00±0.05	12.0±0.10	1.0±0.07



Approval Specification for Anti-Sulfuration Wide Terminal Thick Film Chip Resistors-Type AW

11. 上胶带剥离力测试 (Peel force of top cover tape)

上胶带以 200mm/分钟的速度，沿 165~180 度角的方向进行剥离，如下图所示。纸带的剥离力范围为 10g~70g；载带的剥离力范围为 15g~80g。

The top cover tape is pulled at a speed of 200 mm/min with the angle between the tape during peel and the direction of unreeling maintained at 165 to 180 degree as following picture. The peel force of paper carrier tape shall be 0.10N to 0.70N (10g to 70 g), the peel force of plastic carrier tape shall be 0.15N to 0.80 (15g to 80 g)

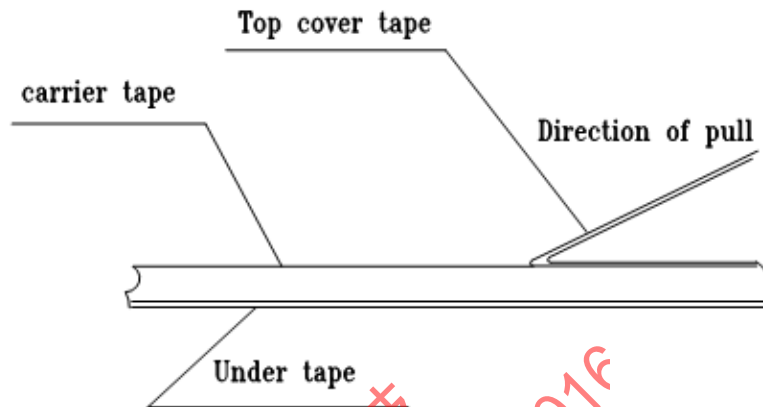

12. 焊盘尺寸 (Recommended land patterns):

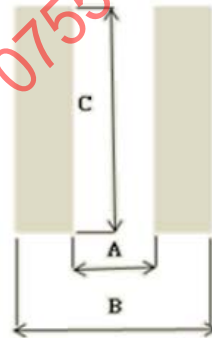

焊盘式样 Land pattern 型别 Type	尺寸 Dimensions (mm)		
	A	B	C
AW0612	0.70	2.60	3.50
AW1020	0.50	3.50	5.30
AW1225	1.30	4.20	6.40



Approval Specification for Anti-Sulfuration Wide Terminal Thick Film Chip Resistors-Type AW

13. 焊接 (soldering)

13.1 建议回流焊曲线 (Recommend reflow soldering profile)

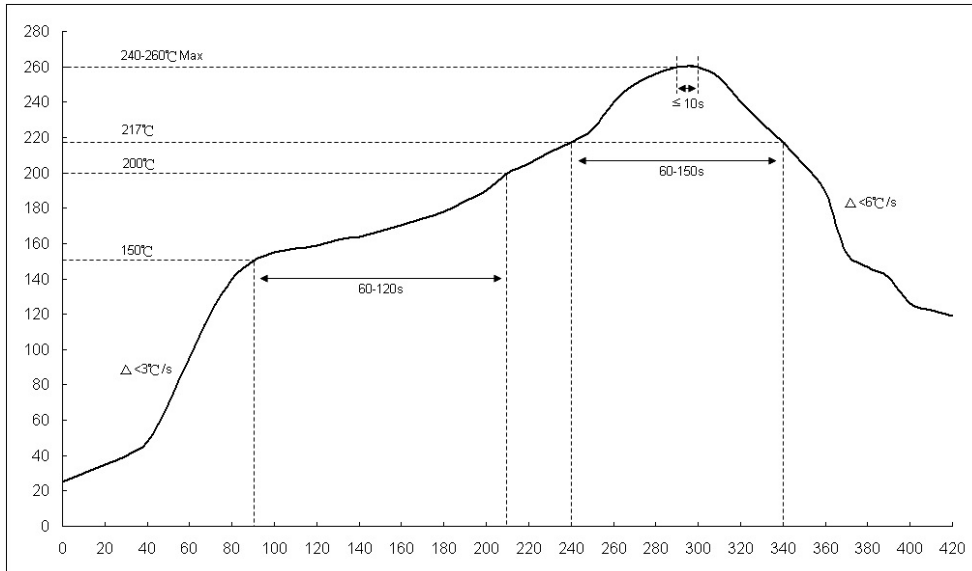

13.2 建议波峰焊曲线 (Recommend wave soldering profile)

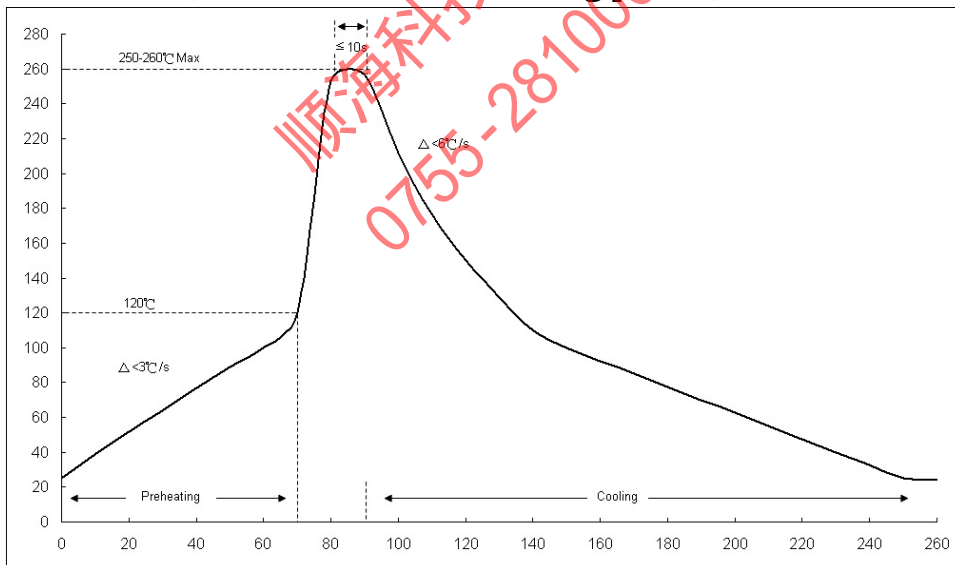

13.3 手工焊温度 (hand soldering temperature)

烙鐵溫度 $350 \pm 10^{\circ}\text{C}$ 3 秒之內，避免烙鐵接觸電阻本體

The iron temperature is $350 \pm 10^{\circ}\text{C}$, hand soldering time less than 3S. Avoid solder iron tip direct touch the components body.

产品规格及资料如有更改，恕不另行通知。

All product specification and data are subject to change without notice