

LED 厚膜贴片电阻承认书-CR 系列

Approval Specification for LED Thick Film Chip Resistors - Type **CR**

1. 范围 (scope) :

1.1 适用于本公司所生产的无铅、无卤之 LED 厚膜贴片电阻 CR 系列

This specification applies to LED thick film chip resistors which meet requirements of Pb free and halogen free.

1.2 本公司的无铅产品指的贴片电阻端电极无铅，而存在于电阻层的玻璃中的符合 RoHS 豁免条款。

There no lead exists in terminal of resistor, and lead which exist in glass of resistor layer meets RoHS exemption.

2. 产品料号 (part number) :

1206 1/4W 5% 150 Ω

CR1206J40151G







<u>CR</u>	<u>1206</u>	<u>J</u>	<u>4</u>	<u>0151</u>	<u>G</u>
类型(Type) CR: 厚膜贴片 电阻(thick film chip resistors)	尺寸(Size) 1206 0805	公差 Tolerance F=±1% G=±2% J=±5%	额定功率 Rated Power 4= 1/4W 8= 1/8W	阻值 Resistance value ±2% , ±5% : 0151=150 Ω ±1% : 1500=150 Ω	包装代码 Packing Code G= reel (卷装) V= bulk (散料) S= Double Standard Quantity (两倍卷 盘标准包装量)



LED 厚膜贴片电阻承认书-CR 系列

Approval Specification for LED Thick Film Chip Resistors - Type **CR**

3. 电阻本体字码标示(Marking on the Resistor's Body):

<p>※ 公差±2%,±5%的产品, 以三字码标示, 前两位表示阻值的有效数字, 最后一位表示 10 的乘幂 ±2%,±5% tolerance product: the marking is 3 digits, the first 2 digits are significant figures of resistance value and the 3rd one denotes the power number of 10, (10^x)</p> <p>※ ±1%的产品, 以四字码标示, 前三位表示阻值的有效数字, 最后一位表示 10 的乘幂 ±1% tolerance product: the marking is 4 digits, the first 3 digits are significant figures of resistance value and the 4th one denotes the power number of 10, (10^x)</p>		472=47×10 ² =4.7KΩ
		10Ω 以下标示: 5R6=5.6Ω Below 10Ω: 5R6=5.6Ω
		4992=499×10 ² =49.9KΩ
		100Ω 以下标示: 6R81=6.81Ω Below 10Ω: 6R81=6.81Ω

4. 尺寸 (dimension) :

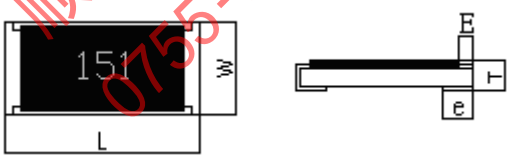
尺寸 dimension						单位 (unit) : mm
型别 (Type)	L	W	T	E	e	
CR0805	2.00±0.15	1.25±0.15	0.50±0.10	0.35±0.20	0.40±0.20	
CR1206	3.10±0.15	1.60±0.15	0.55±0.10	0.45±0.25	0.40±0.25	



LED 厚膜贴片电阻承认书-CR 系列

Approval Specification for LED Thick Film Chip Resistors - Type **CR**

5. 功率衰减曲线 (Derating Curve) :

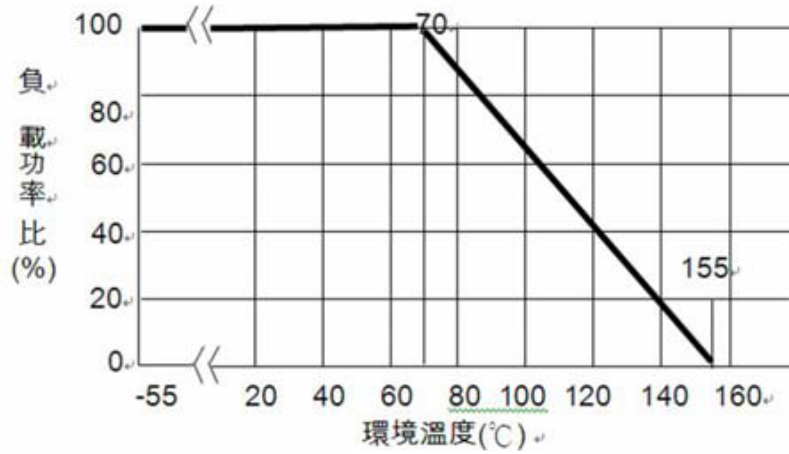

工作温度范围 (Operating Temperature Range) : $-55^{\circ}\text{C} \sim +155^{\circ}\text{C}$;

储存条件 (storage condition) : $5 \sim 30^{\circ}\text{C}$, $30 \sim 75\% \text{RH}$.

6. 电阻结构 (Construction) :

顺海科技
0755-28100016

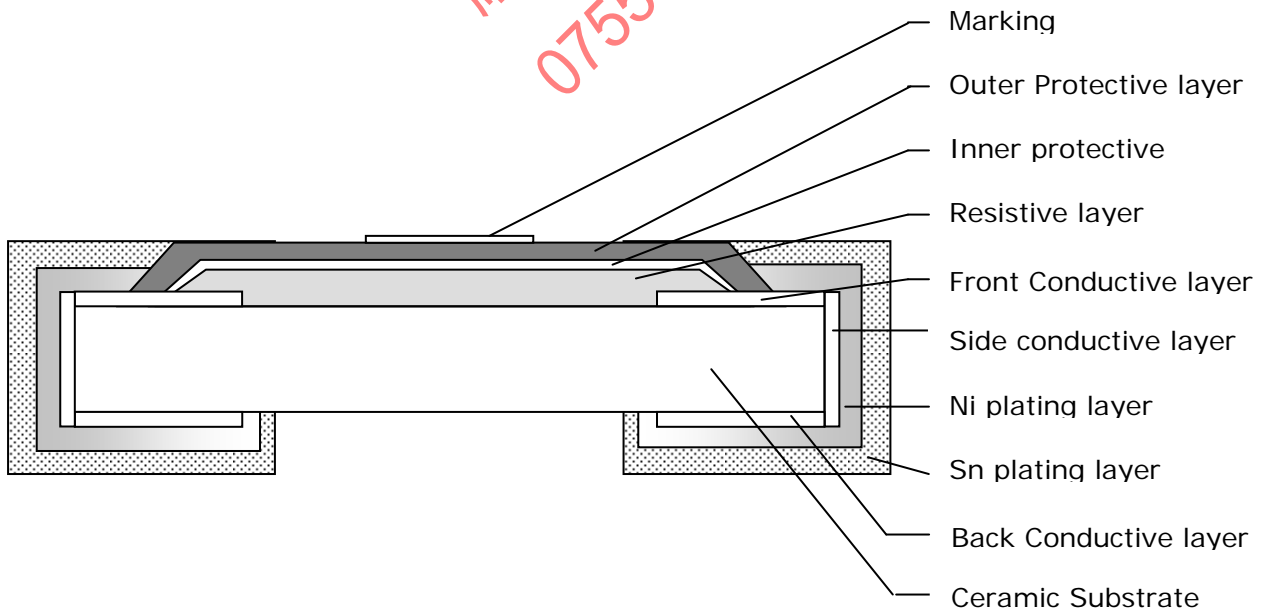



LED 厚膜贴片电阻承认书-CR 系列

Approval Specification for LED Thick Film Chip Resistors - Type **CR**

No.	结构 construction	主要材料 Major material
1	陶瓷基板 Ceramic substrate	三氧化二铝 Al ₂ O ₃
2	正面导体层 Front Conductive layer	银 Ag
3	背面导体层 Back Conductive layer	铝 Al
4	侧电极 Side conductive layer	镍铬合金 NiCr
5	阻体层 Resistive layer	氧化钌+玻璃 RuO ₂ + glass
6	内保护层 Inner protective layer	玻璃 Glass
7	外保护层 Outer Protective layer	环氧树脂 Epoxy
8	文字 Marking	环氧树脂 Epoxy
9	镍电极 Ni plating layer	镍 Ni
10	锡电极 Sn plating layer	雾锡 Matte Tin

7. 阻值范围 (resistance range) :

型别 Type	阻值范围 Resistance Range		
	1%	2%	5%
0805	10Ω~10KΩ	10Ω~10KΩ	10Ω~10KΩ
1206	10Ω~10KΩ	10Ω~10KΩ	10Ω~10KΩ



LED 厚膜贴片电阻承认书-CR 系列

Approval Specification for LED Thick Film Chip Resistors - Type **CR**

8. 电气特性 (electrical characteristics) :

型别 Type	0805	1206
额定功率 Rated power	1/8W	1/4W
最大工作电压 Max Working Voltage	150V	200V
最大过负荷电压 Max Overload Voltage	300V	400V
绝缘耐压 Dielectric Withstanding Voltage	430V	570V

备注 (remark) :

※ 额定电压计算公式 (The rated voltage is calculated by the following formula) :

$$E = \sqrt{RP}$$

E : 额定电压 (Rated Voltage) (V)

P : 额定功率 (Rated Power) (W)

R : 电阻阻值 (Resistance) (ohm)

※ 如果计算出的电压超过此型别的最大工作电压, 则此型别的最大工作电压为此电阻的额定电压。

In case the value calculated by the formula exceed the maximum working voltage as above table 8, the maximum working voltage shall be regarded as rated voltage.



LED 厚膜贴片电阻承认书-CR 系列

Approval Specification for LED Thick Film Chip Resistors - Type **CR**

9.性能信赖性测试 (Performance Reliability Test Methods)

内容 Item	测试方法 Test Methods	测试条件 Test Conditions	规格 Specification
温度系数 Temperature Coefficient	JIS C 5201 4.8	$TCR = (R - R_0) / (t - t_0) R_0 \times 10^6 \text{ (ppm)}$ R ₀ 电阻在室温下的阻值(resistance at room temperature) R 电阻在 125°C 或 -55°C 下的阻值(resistance at 125°C or -55°C) t ₀ 室温(room temperature) t 测试温度 (test temperature 125°C or -55°C)	±100 PPM/°C
焊锡性 Solderability	JIS C 5201 4.17	沾助焊剂后浸入锡炉，锡炉温度 245±5°C，时间 3±0.5 秒。 Dip the terminal in a flux and then dip into a soldering bath at 245±5°C for 3±0.5sec.	最少 95% 面积上锡 (Min 95% coverage)
绝缘电阻 Insulation resistance	JIS C 5201 4.6	电阻本体上加载绝缘耐压 60±5 秒后，测量绝缘阻抗。 Applied the dielectric withstanding voltage on the center of body for 60±5seconds. Then measure insulation resistance	>10GΩ
绝缘耐压 Dielectric withstanding voltage	JIS C 5201 4.7	电阻本体上加载绝缘耐压 60±5 秒。 Applied the dielectric withstanding voltage on the center of body for 60±5seconds.	无击穿、飞弧及可见机械性损伤 No evidence of flashover, mechanical damage arcing or insulation breakdown
短时间过负荷 Short-time overload	JIS C 5201 4.13	加载 2.5 倍的额定电压，时间 5 秒后测量试验前后的阻值变化率。 Applied 2.5 times of rated voltage for 5 second. Measure the variation of resistance. $\Delta R\% = \frac{R_2 - R_1}{R_1} * 100 \text{----- (\%)}$ R ₁ = 试验前阻值(resistance before test) R ₂ = 试验后阻值(resistance after test)	±(1.0% + 0.05 Ω) Max



LED 厚膜贴片电阻承认书-CR 系列

Approval Specification for LED Thick Film Chip Resistors - Type **CR**

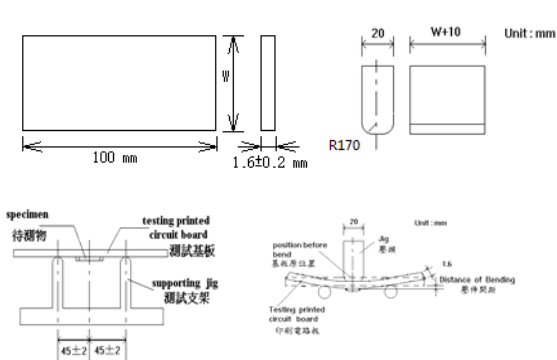
内容 Item	测试方法 Test Methods	测试条件 Test Conditions	规格 Specification
抗焊锡热 Resist to soldering heat	JIS C 5201 4.18	沾助焊剂后浸入锡炉，锡炉温度 260±5℃，时间 10±0.5 秒，测量试验前后的阻值变化率。 Dip the terminal in a flux and then dip into a soldering bath at 260±5℃ for 10±0.5sec. Measure the variation of resistance. $\Delta R\% = \frac{R_2 - R_1}{R_1} * 100 \text{-----} (\%)$ R1 = 试验前阻值(resistance before test) R2 = 试验后阻值(resistance after test)	±(1.0%+0.05 Ω) Max
端子弯曲 Terminal bending	JIS C 5201 4.33	电阻焊接在测试板上进行弯折,弯折保持时间 20±1 秒，1206(含) 以下的尺寸弯曲 5 ^{+0.2} %mm; 1206 以上的尺寸弯曲 2 ^{+0.2} %mm; 量测试验前后阻值变化率。 Specimen shall be mounted on test board, then bend the board and maintained for 20±1s. the distance of bending is 5 ^{+0.2} %mm for resistors which size no larger than 1206 or 2 ^{+0.2} %mm which size larger than 1206. Measure the variation of resistance. 测试板 (test board) 压头 (jig) <div style="text-align: center;">  </div> $\Delta R\% = \frac{R_2 - R_1}{R_1} * 100 \text{-----} (\%)$ R1 = 试验前阻值(resistance before test) R2 = 试验后阻值(resistance after test)	±(1.0%+0.05 Ω) Max



LED 厚膜贴片电阻承认书-CR 系列

Approval Specification for LED Thick Film Chip Resistors - Type **CR**

内容 Item	测试方法 Test Methods	测试条件 Test Conditions	规格 Specification
温度循环 Temperature Cycling	JIS C 5201 4.19	电阻放入温度循环机中，温度 155±2℃ 至 -55±3℃，共 5 个循环。量测试验前后阻值变化率。 Put specimen in a chamber which temperature can be changed to 155±2℃ or -55±3℃, repeated 5 times. Measure the variation of resistance. $\Delta R\% = \frac{R_2 - R_1}{R_1} * 100 \text{-----} (\%)$ R1 = 试验前阻值(resistance before test) R2 = 试验后阻值(resistance after test)	±(2.0%+0.05 Ω) Max
耐湿特性 Humidity	JIS C 5201 4.24	电阻放入恒温恒湿箱，温度 40±2℃，湿度 90~95 %RH;通电额定电压 1.5 小时，断电 0.5 小时；重复通断电至试验时间 1000 ⁺⁴⁸ / ₋₀ 小时，量测试验前后阻值变化率。 Put the specimen in a chamber at 40±2℃ temperature and 90~95% relative humidity, then applied rated voltage for 1.5H and rested for 0.5H repeatedly till total test time is 1000 ⁺⁴⁸ / ₋₀ .. Measure the variation of resistance. $\Delta R\% = \frac{R_2 - R_1}{R_1} * 100 \text{-----} (\%)$ R1 = 试验前阻值(resistance before test) R2 = 试验后阻值(resistance after test)	±(2.0%+0.05 Ω) Max
负荷寿命 Load life	JIS C 5201 4.25.1	电阻放入恒温箱中，温度 70±2℃，ON TIME:1.5H，OFF TIME:0.5H，通电额定电压 1000 ⁺²⁴ / ₋₀ 小时，量测试验前后阻值变化率。 Put the specimen in a chamber at 70±2℃ temperature, ON TIME:1.5H，OFF TIME:0.5H，and applied rated voltage for 1000 ⁺²⁴ / ₋₀ H. Measure the variation of resistance. $\Delta R\% = \frac{R_2 - R_1}{R_1} * 100 \text{-----} (\%)$ R1 = 试验前阻值(resistance before test) R2 = 试验后阻值(resistance after test)	±(2.0%+0.05 Ω) Max



LED 厚膜贴片电阻承认书-CR 系列

Approval Specification for LED Thick Film Chip Resistors - Type **CR**

内容 Item	测试方法 Test Methods	测试条件 Test Conditions	规格 Specification
温湿循环 Moisture resistance	MIL-STD-202 METHOD 106	25 ° C~65 ° C,90~100%RH, 2.5 小时 ; 65 ° C 90~100%RH, 3小时; 65°C~25°C,80~100%RH,2.5 小时,10个循环,试验结束24±4小时后进行测 试。 25°C~65°C,90~100%RH, 2.5H; 65°C 90~100%RH, 3H; 65°C~25°C 80~100%RH, 2.5H, 10 cycles, Measurement at 24±4 hours after test conclusion. $\Delta R\% = \frac{R_2 - R_1}{R_1} * 100 \text{-----} (\%)$ R1 = 试验前阻值(resistance before test) R2 = 试验后阻值(resistance after test)	±(2.0% +0.05Ω) Max

10. 包装规格 (Tapping Specification)

10.1 卷盘尺寸 (reel dimension)

尺寸 Dimensions		A	B	C	F	W
CR0805	mm	178±2.0	60.0±1.0	13.5±0.5	11.4±0.1	9.00±0.3
CR1206	Inch	7.008±0.079	2.362±0.039	0.531±0.020	0.449±0.039	0.354±0.012

※ 备注 (Remark) : 0805、1206 每卷 5,000pcs

0805、1206 Quantity per Reel 5,000 pcs/Reel

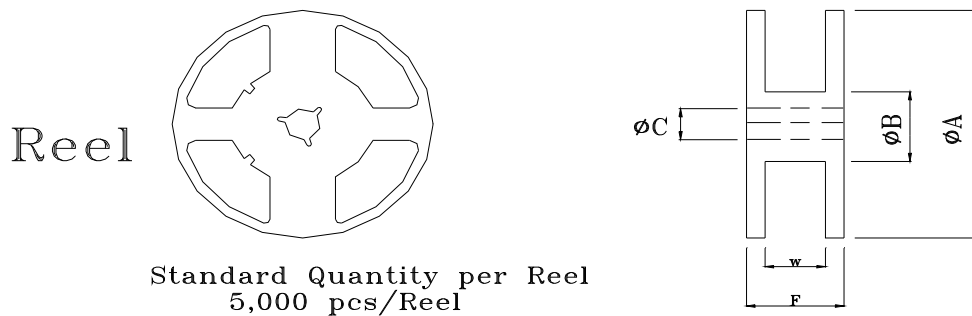

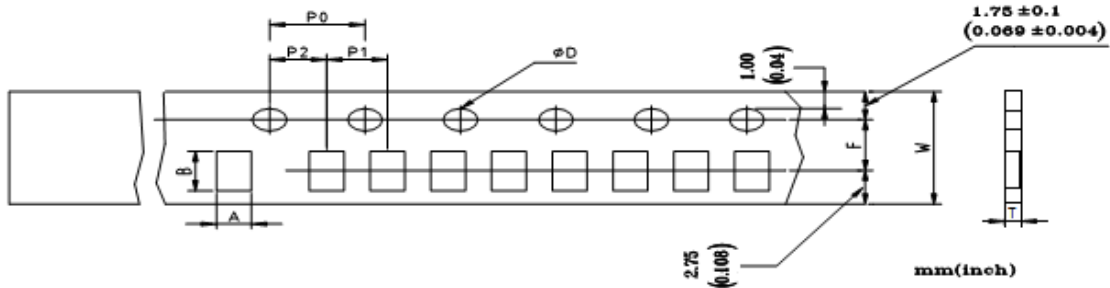
10.2 包装尺寸 (packing dimension)

Unit: mm

尺寸 Dimensions	A	B	D	F	P0	P1	P2	W	T
CR0805	1.65±0.20	2.40±0.20	1.50± $\frac{0.1}{0.0}$	3.50±0.05	4.00±0.10	4.00±0.10	2.00±0.05	8.00±0.20	0.75±0.07
CR1206	2.00±0.20	3.60±0.20	1.50± $\frac{0.1}{0.0}$	3.50±0.05	4.00±0.10	4.00±0.10	2.00±0.05	8.00±0.20	0.75±0.07

11. 上胶带剥离力测试 (Peel force of top cover tape)

上胶带以 200mm/分钟的速度，沿 165~180 度角的方向进行剥离，如下图所示。纸带的剥离力范围为 10g~70g；载带的剥离力范围为 15~80g。

The top cover tape is pulled at a speed of 200mm/min with the angle between the tape during peel and the direction of unreeling maintained at 165 to 180 degree as following picture. The peel force of paper carrier tape shall be 0.1N to 0.7N (10 to 70 g), the peel force of plastic carrier tape shall be 0.15N to 0.8N (15 to 80 g)

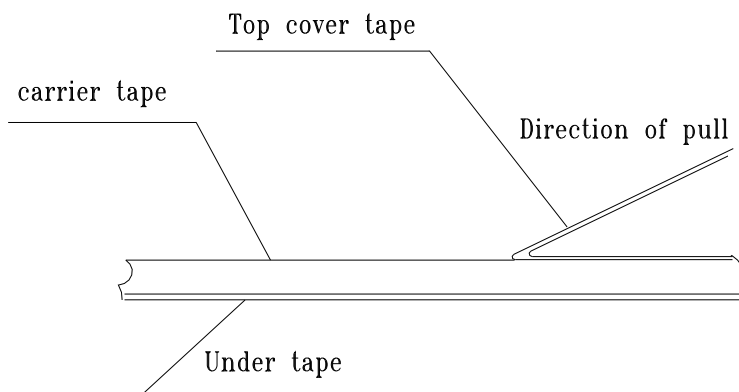



LED 厚膜贴片电阻承认书-CR 系列

Approval Specification for LED Thick Film Chip Resistors - Type **CR**

12. 焊盘尺寸 (Recommended land patterns):

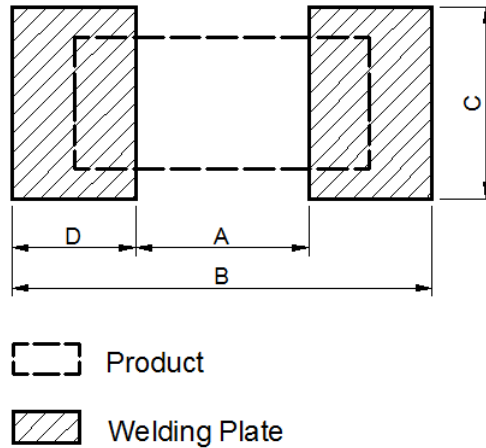

焊盘式样 Land pattern 型别Type	尺寸 Dimensions (mm)			
	A	B	C	D
CR0805	1.00~1.40	3.20~3.80	0.90~1.40	1.10~1.20
CR1206	2.00~2.40	4.40~5.00	1.20~1.80	1.15~1.35

13. 焊接 (soldering)

13.1 建议回流焊曲线 (Recommend reflow soldering profile)

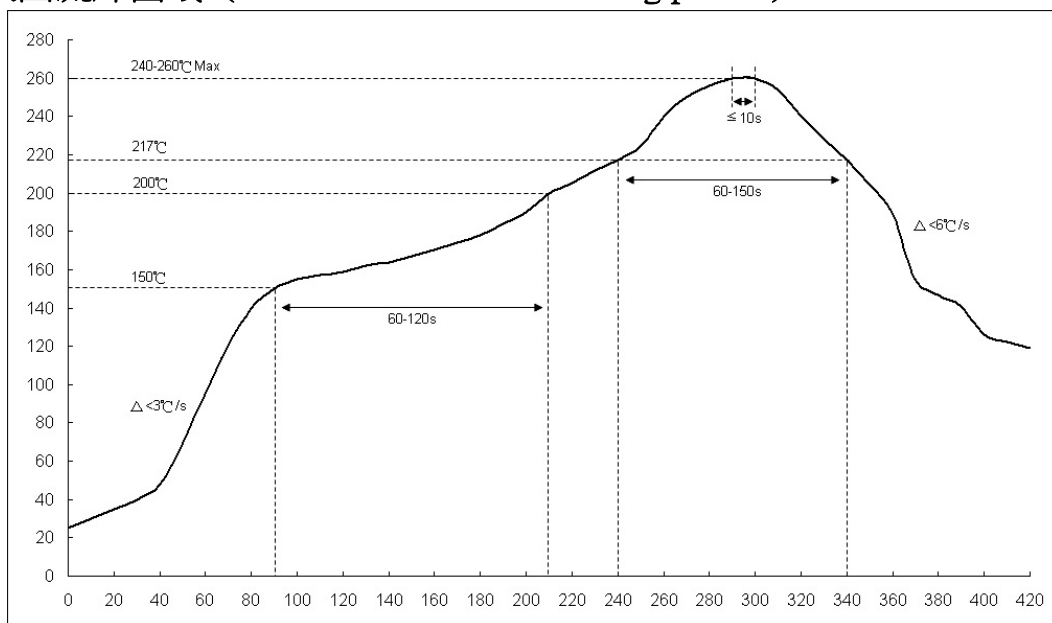



13.2 建议波峰焊曲线 (Recommend wave soldering profile)

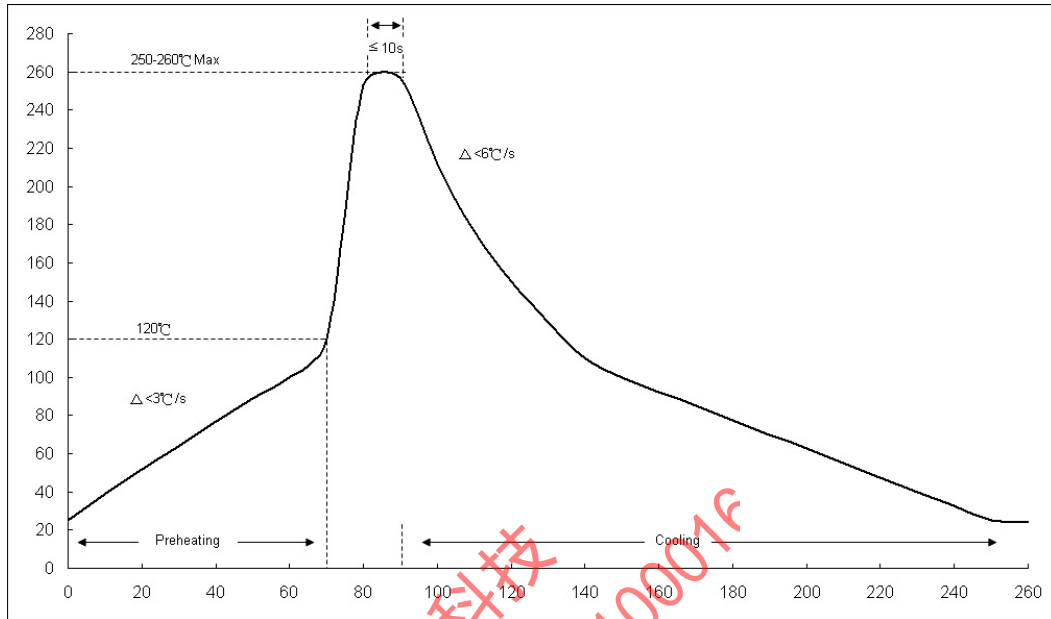

13.3 手工焊温度 (hand soldering temperature)

烙鐵溫度 $350 \pm 10^{\circ}\text{C}$ 3 秒之內，避免烙鐵接觸電阻本體

The iron temperature is $350 \pm 10^{\circ}\text{C}$, hand-soldering time less than 3S. Avoid solder iron tip direct touch the components body.

产品规格及资料如有更改，恕不另行通知。

All product specification and data are subject to change without notice.